

# GEMINI

## Overview

The RGL150 Series is a 150W single voltage integrated 2U rackmount power system that provides system or lock power. The Gemini rack-mounted drawer provides easy access to power components for installation, configuration, and service.

An FPO150 power supply provides single voltage operation, while charging up to 80AH of battery. Available options include power distribution and control, individual output protection by either fuses or class 2 power limiting, buffered lock control, and remote reporting and test. Each output is protected against electrical surges caused by lightning or transients on the external wiring (SurgeShield™) and each control output is individually selectable for either failsafe or failsecure operation with fire alarm interface.

Optional network reporting capabilities include: operational fault status; power supply output; battery charging voltage; battery charging current; and fire alarm input status. In addition to automated and scheduled status reports, diagnostic servicing and battery load tests can be performed remotely, saving or reducing the cost of on-site servicing.

The unit is intended for mounting within a standard four post EIA 19 inch electronics rack with a maximum depth of 36 inches.

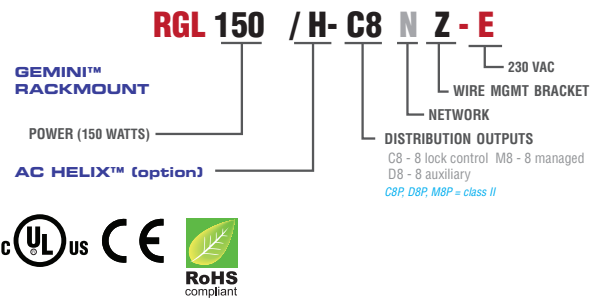

## Rackmount Features

- ♦ Integrated access system with lock or system power distribution
- ♦ Compartmentalized architecture for maximum reliability
- ♦ Rack drawer slide assembly simplifies wiring and maintenance
- ♦ Comprehensive wire management with tie down points and articulating bracket
- ♦ 120 or 230V AC user selectable input supports data center electrical systems

## Configuration Options

- ♦ Single voltage 12 or 24VDC with distribution options cover all access functions
- ♦ Power distribution for either direct (D8) buffered (C8) or managed (M8)
- ♦ Individual output selection for failsafe, failsecure, and fire alarm interface
- ♦ High capacity battery charge capability
- ♦ Automotive fuses for ease of service and replaceability
- ♦ Easy expansion with additional modules or multiple Gemini drawers
- ♦ Available companion battery housing for rackmount use (part number RBE)

## Network Monitoring

- ♦ Monitor/alert power supply, battery operation and faults
- ♦ Remote test battery run time, low battery and time to service alert
- ♦ Monitor/power cycle individual outputs (M8N model)
- ♦ Monitor alert external room temperature

## Fire Alarm Interface

- ♦ Latching or Non-latching | Remote reset capability
- ♦ Normally Open, Normally Closed
- ♦ Voltage or Polarity Reversal Activation

## Comprehensive fault detection and reporting

- ♦ May be connected into access controller or used standalone
- ♦ Form C contact transfer for AC Loss or brownout
- ♦ Form C contact transfer for abnormal system operation

## Agency Listings

- ♦ UL, CUL, CE Access Control

## Lifetime Warranty

## Ordering

Model No.	Network	Voltage	Current	Internal Distribution			
				Bulk	Auxiliary	Control	Managed
RGL150-Z		12V or 24V	12A or 6A	2			
RGL150-D8Z				2	8		
RGL150-2D8Z				2	16		
RGL150-2C8Z				2		16	
RGL150-2M8NZ	Yes			2			16
RGL150-2D82M8NZ	Yes			2	16		16
RGL-XZ				Rackdrawer only			

*Dual voltage - outputs can be individually set for 12V or 24VDC*

*Networking - monitors power supply, battery set and relay control outputs*

*For Class II power limiting add "P" to accessory module in model number, ie C8P, D8P, M8P*

*For AC Helix dual AC inputs, add /H after power supply, ie RGL150/H-2D8Z*

*For CE 230VAC option, add "-E" suffix to model number, ie RGL150-D8Z-E*

*Z Bracket suffix. Z is standard, Z1 is heavy duty (for use with distributed outputs)*

**Specifications**

<b>Input Power</b>	Input 120/230 VAC 50/60 Hz   200 Watts Thermal overload protection / Short circuit protection
<b>Output Power</b>	FPO150 150 Watts: 12 amps at 12 VDC or 6 amps at 24 VDC
<b>Internal Power Distribution</b>	D8/D8P eight auxiliary outputs: D8 fused at 3A/ea, D8P Class II Power limited at 2.5A/ea C8/C8P eight control outputs: C8 fused at 3A/ea, C8P Class II Power limited at 2.5A/ea M8/M8P eight managed outputs: M8 fused at 3A/ea, M8P Class II Power limited at 2.5A/ea
<b>Supervision</b>	AC input, DC1, and DC2 output Low battery and battery presence supervision (form C contacts) AC fail supervision (form C contacts) System Fault, AC Fault, Ground Fault, Reverse Battery
<b>External Indicators</b>	AC on master on/off switch
<b>Battery Charging</b>	FPO150 - Maximum charge current 2.0 amp   Maximum battery capacity 80Ah Independent built-in charger for sealed lead acid or gel type batteries Microprocessor dual rate charging of 12 or 24 V battery sets Automatic switchover to standby battery when AC fails Zero voltage drop when switched over to battery backup
<b>Regulatory Compliance</b>	UL294 6th Edition, UL603, UL1076, ULC S318, ULC S319, CE
<b>BTU Rating</b>	66 BTU/Hr
<b>Physical Dimensions</b>	2U rack mount (19.00"W x 3.50"H x 20.50"D) with wire management articulating arm   Weight 27 lbs.

*Drawer layout example of FPO150*

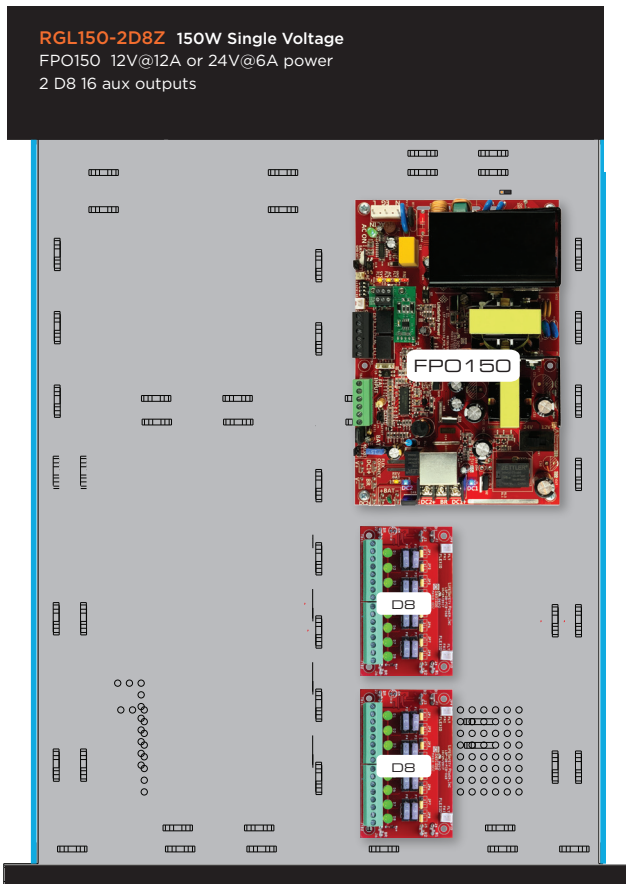

*Drawer layout example with 16 aux and 16 managed outputs*

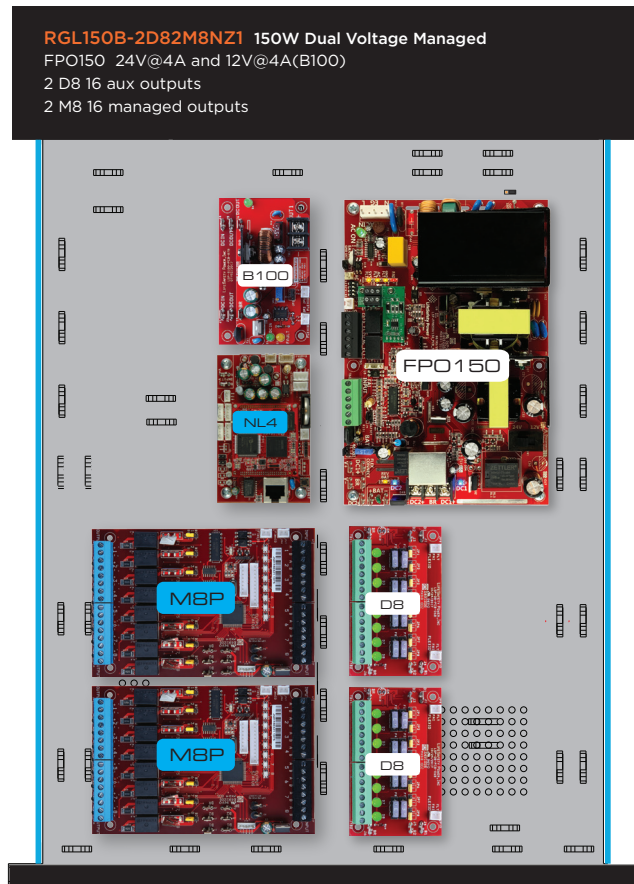

**INTERNAL POWER DISTRIBUTION options**

**D8 - DISTRIBUTED POWER TO ACCESS CONTROLLER**

- Eight individually protected power outputs**
- D8 Fused at 3A per output
  - D8P Class 2 power limited at 2.5A per output

- Visual Indicators**
- DC Presence: Green/Blue LED per output

- Removable terminals**
- Accepts #12 to #24 AWG

**C8 / M8 - CONTROL OUTPUTS FOR LOCKS**

- 8 access control trip inputs**
- 8 individually protected lock control outputs**
- C8 / M8 Fused at 3A per output
  - C8P / M8P Class 2 power limited at 2.5A per output

- Each input may be programmed to respond to:**
- Application of voltage between 9 and 33VDC
  - Removal of voltage between 9 and 33VDC
  - Normally open dry contact transition
  - Normally closed dry contact transition

- Each output may be programmed for the following modes:**
- Fail-safe, Fail-secure
  - Fire alarm over ride for egress lock control

- Visual Indicators**
- DC Presence: Green/Blue LED per output
  - Fault Condition: Yellow fault LED

- Removable terminals**
- Accepts #12 to #24 AWG

**FAULT DETECTION AND REPORTING**

**DETECTED FAULT CONDITIONS (ALL MODELS)**

- AC Power**
- AC loss, AC low, Master AC power switch
- DC Power and System**
- Abnormal or loss of power supply operation
  - Over current, over temperature condition
  - DC output high, low
  - Battery Presence, Earth Ground (user optional)
  - Reversed battery condition, blown fuse or loss of output voltage on selected accessory boards (detected on the power supply)

**VERSATILE CONFIGURATION OPTIONS**

**RGL150 LSP module pattern**

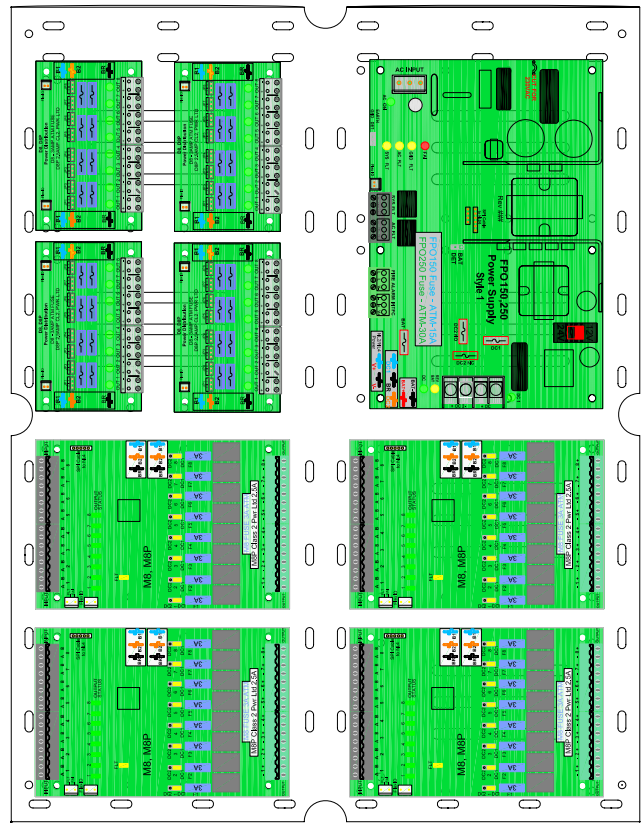

**RGL150 power only pattern**

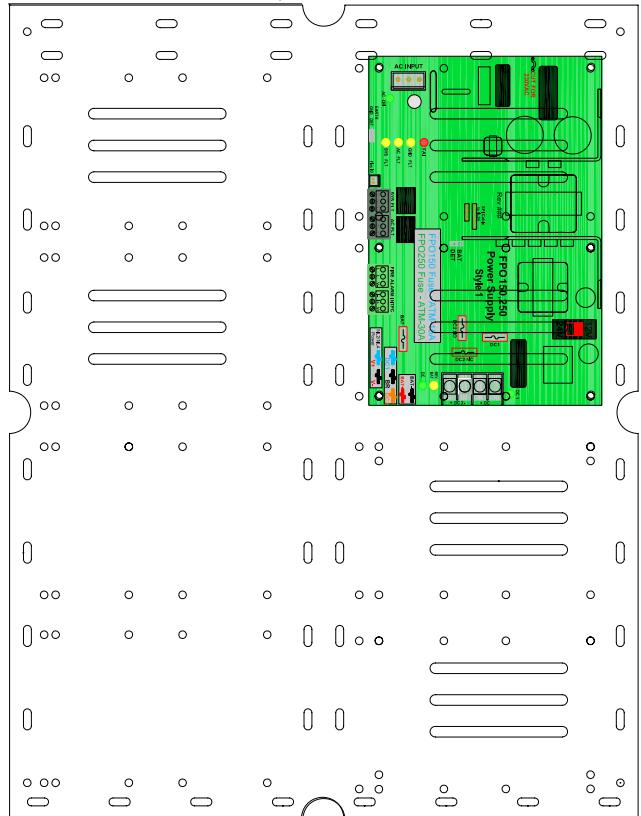

Order model number **RGL-XZ** for bare drawer and backplate

**WIRE MANAGEMENT**

**Wire tie points**

- Drawer tie down points for access wiring
- Back chassis tie down points secures wire bundle

**Cable management articulating arm**

- Bracket with tie wrap points secures access wiring into drawer

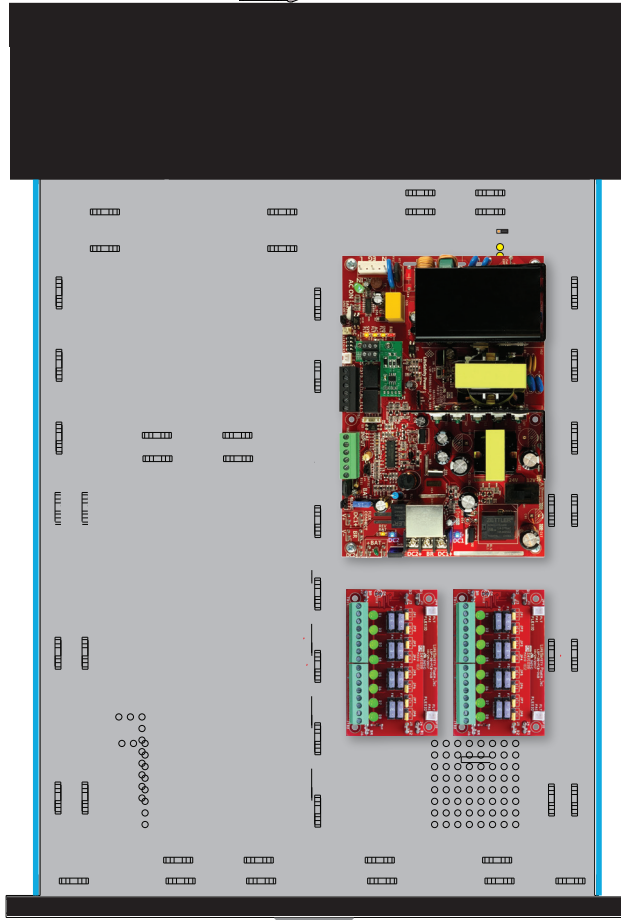
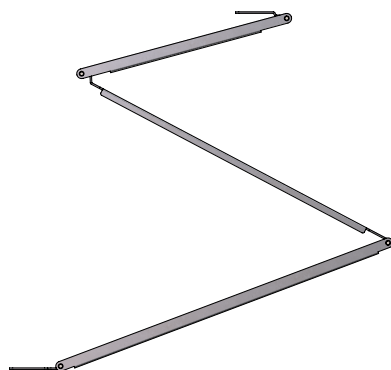

**EXPANSION | BATTERY BACK-UP**

**8-16 Doors**

- Stack multiple Gemini rack mounts for higher door counts
- Add RBE battery enclosure for battery back up

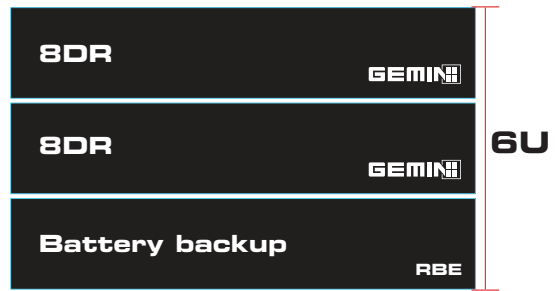

**16 door w/ battery back up**

**Mechanical**

2U rack mount 19.00"W x 3.50"H x 20.50"D  
Weight 27 lbs.

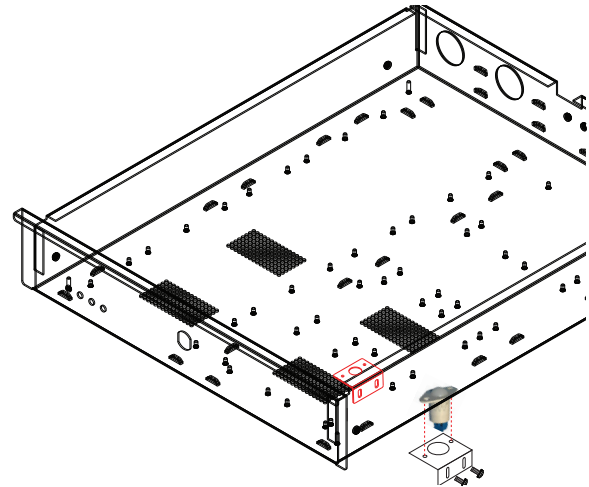
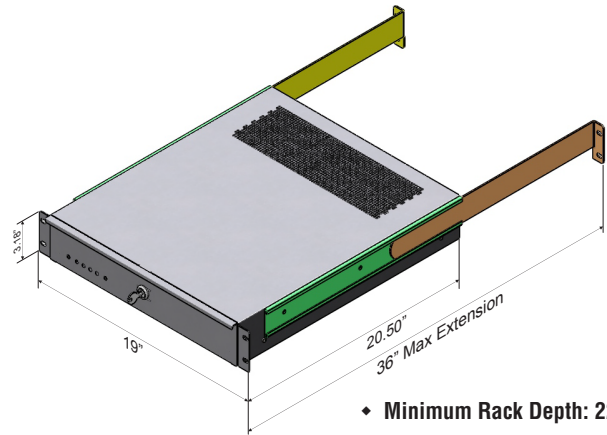
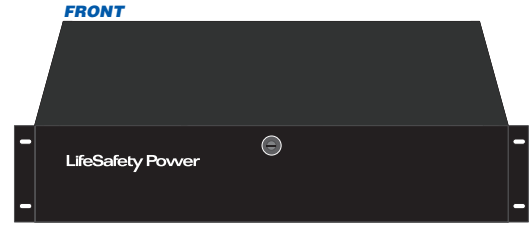
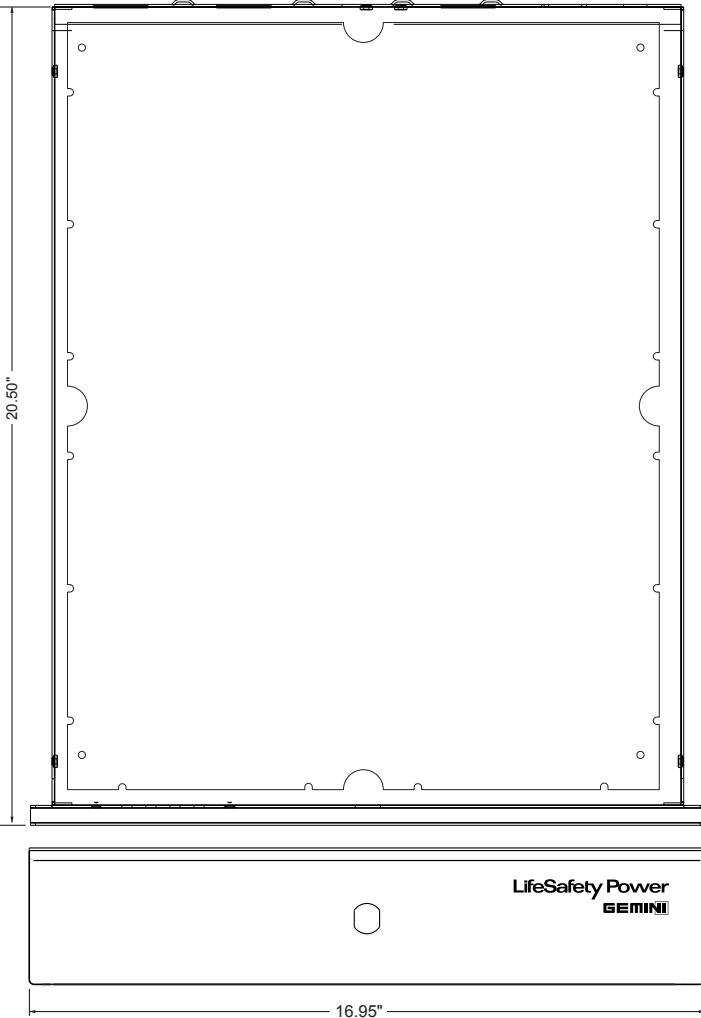
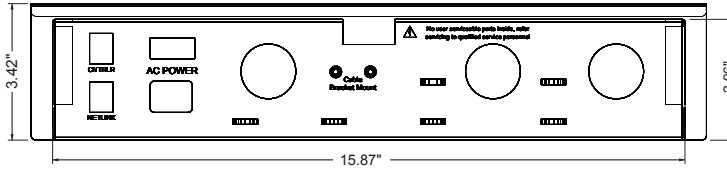

**Included Tamper Switch**

**[lifesafetypower.com](http://lifesafetypower.com)**

(888) 577-2898  
info1@lifesafetypower.com

Specifications subject to change without notice.

© 2022 LifeSafety Power. All rights reserved.

LifeSafety Power and FlexPower are registered trademarks of LifeSafety Power.

P01-993A 07/22

**LifeSafety Power**

10027 S. 51st Street, Suite 102  
Phoenix, AZ 85044 USA